

SIRUBA®

銀爺牌工業用縫紉機

INDUSTRIAL SEWING MACHINE

700FS











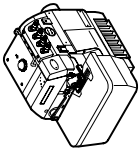





















零件圖 PARTS LIST



CE



高林股份有限公司
KAULIN MFG. CO., LTD.

	GAUGE																			
	NG SM	E304	D103	D102	H104	1.6	P152D-3	—	LP26	KG131	KF25	KJ09B	KJ10	#9	5.5		KL62	KL11	8000	
737FS-505F1-04	4	E304	D103	D102	H104	1.6	P152D-3	—	LP26	KG131	KF25	KJ09B	KJ10	#9	5.5		KL62	KL11	8000	
737FS-505F1-04/ESS	4	E304	D103	D102	H104	1.6	P152D-3	—	LP26	KG131	KF25	KJ09B	KJ10	#9	5.5		KL62	KL11	8000	
737FS-505F1-04/VT	4	E304	D103	D102	H104	1.6	P152D-3	—	LP26	KG131	KF25	KJ09B	KJ10	#9	5.5		KL62	KL11	8000	
737FS-505F1-04/ESS/VT	4	E304	D103	D102	H104	1.6	P152D-3	—	LP26	KG131	KF25	KJ09B	KJ10	#9	5.5		KL62	KL11	8000	
737FS-504M2-04	4	E324	D117	D116	H118	1.6	P987-3	KS62	LP26	KG131	KF26	KJ11B	KJ13	#11	6.5		KL60	KL11	6300	
737FS-504M2-04/VT	4	E324	D117	D116	H118	1.6	P987-3	KS62	LP26	KG131	KF26	KJ11B	KJ13	#11	6.5		KL60	KL11	6300	
737FS-504M2-04/LFC-2S	4	E324	D117	D116	H118	1.6	P111-3	KS62	LP26	KG131	KF26	KJ11B	KJ13	#11	6.5		KL60	KL11	6300	
747FS-514M2-24	2	E434	D117	D116	H118	1.6	P987-4	KS62	LP26	KG142	KF26	KJ11B	KJ13	#11	5.5		KL60	KL11	6000	
747FS-514M2-24/VT	2	E434	D117	D116	H118	1.6	P987-4	KS62	LP26	KG142	KF26	KJ11B	KJ13	#11	5.5		KL60	KL11	6000	
747FS-514M2-24/CT	2	E424	D103	D116	H118	1.6	P987-4	KS62	LP26	KG142	KF26	KJ11B	KJ13	#11	5.5		KL60	KL11	6000	
747FS-514M4-24	2	E424	D103	D116	H118	1.6	P987-4	KS62	LP26	KG142	KF25	KJ69	KJ10	#11	6.5		KL62	KL11	7500	

规格件表 CONVERSION CHART

PARTS LIST FOR KA GROUP

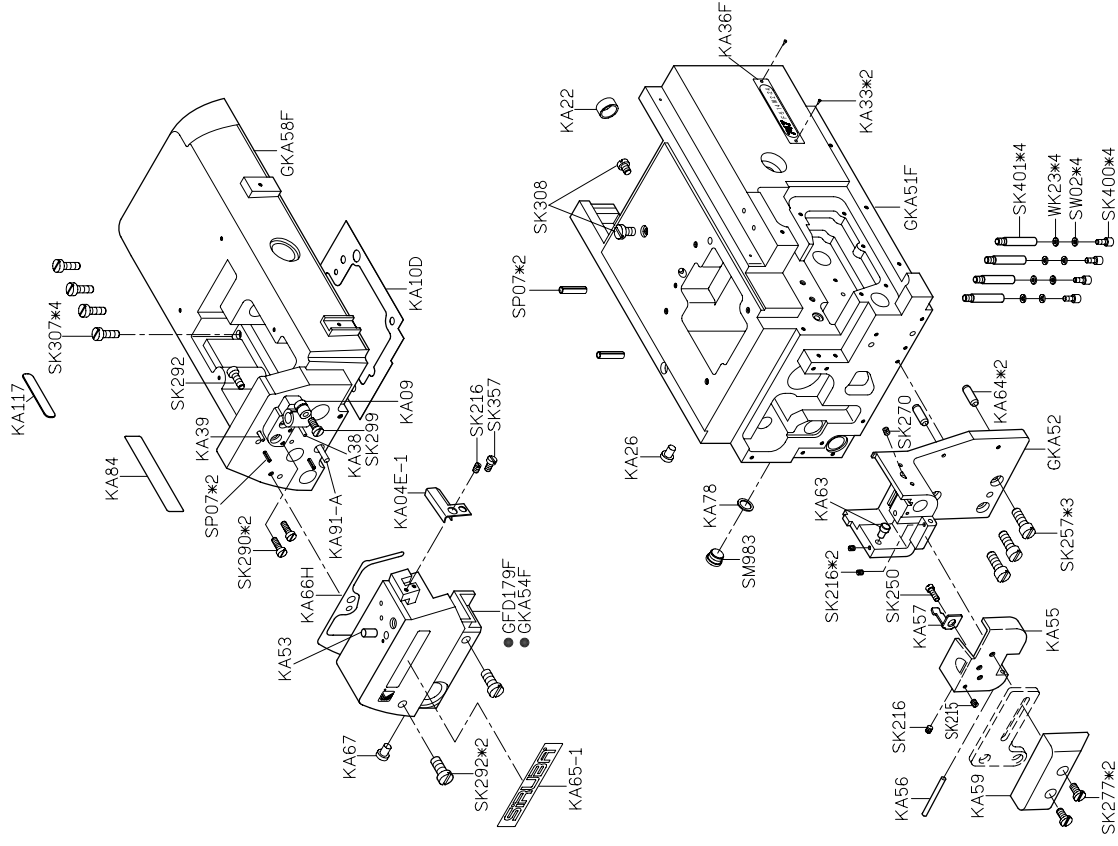

PARTS LIST FOR KB GROUP

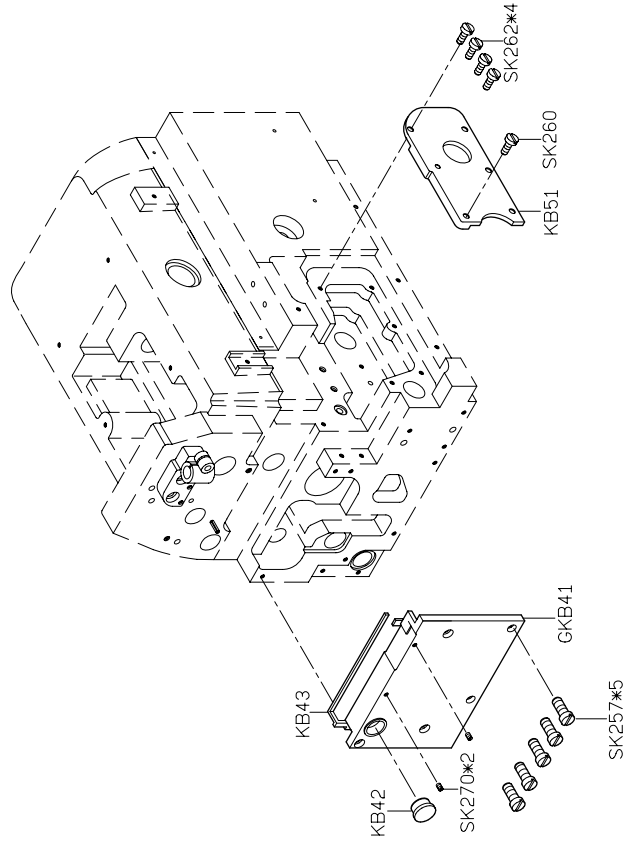

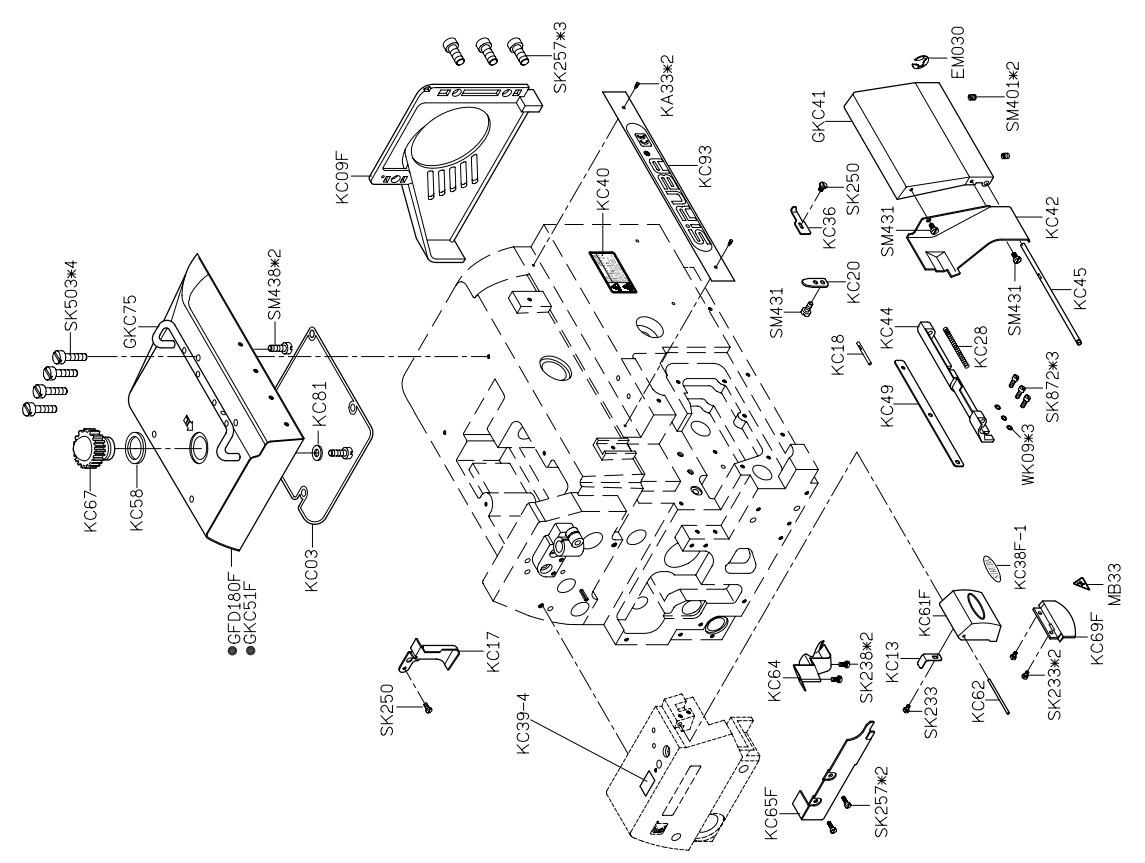
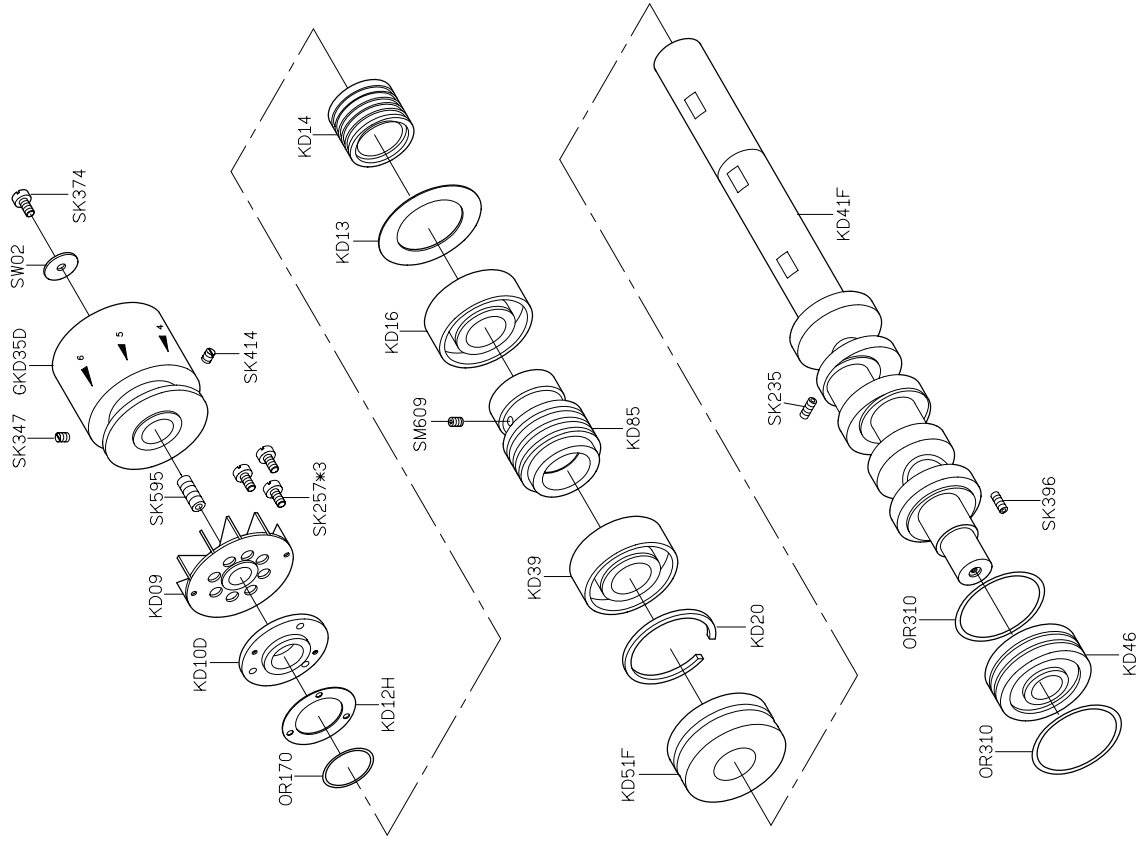

PARTS LIST FOR KD GROUP

PARTS LIST FOR KC GROUP

PARTS LIST FOR KF GROUP

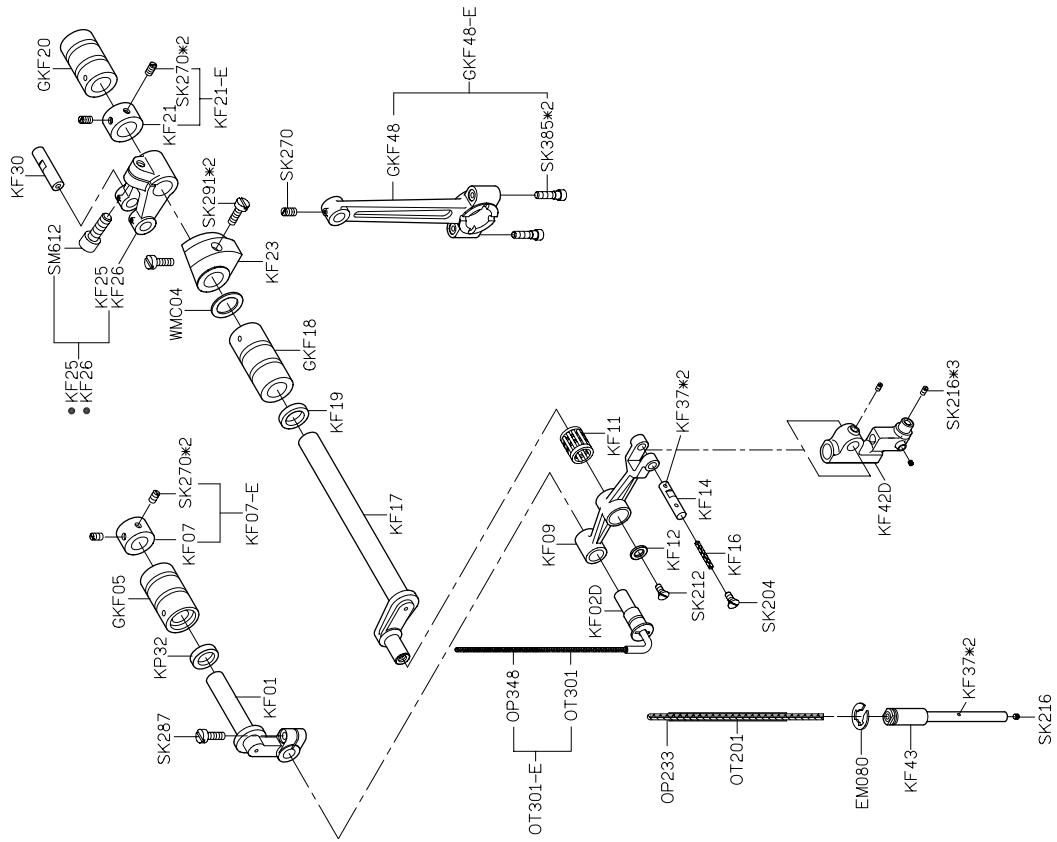

PARTS LIST FOR KG GROUP

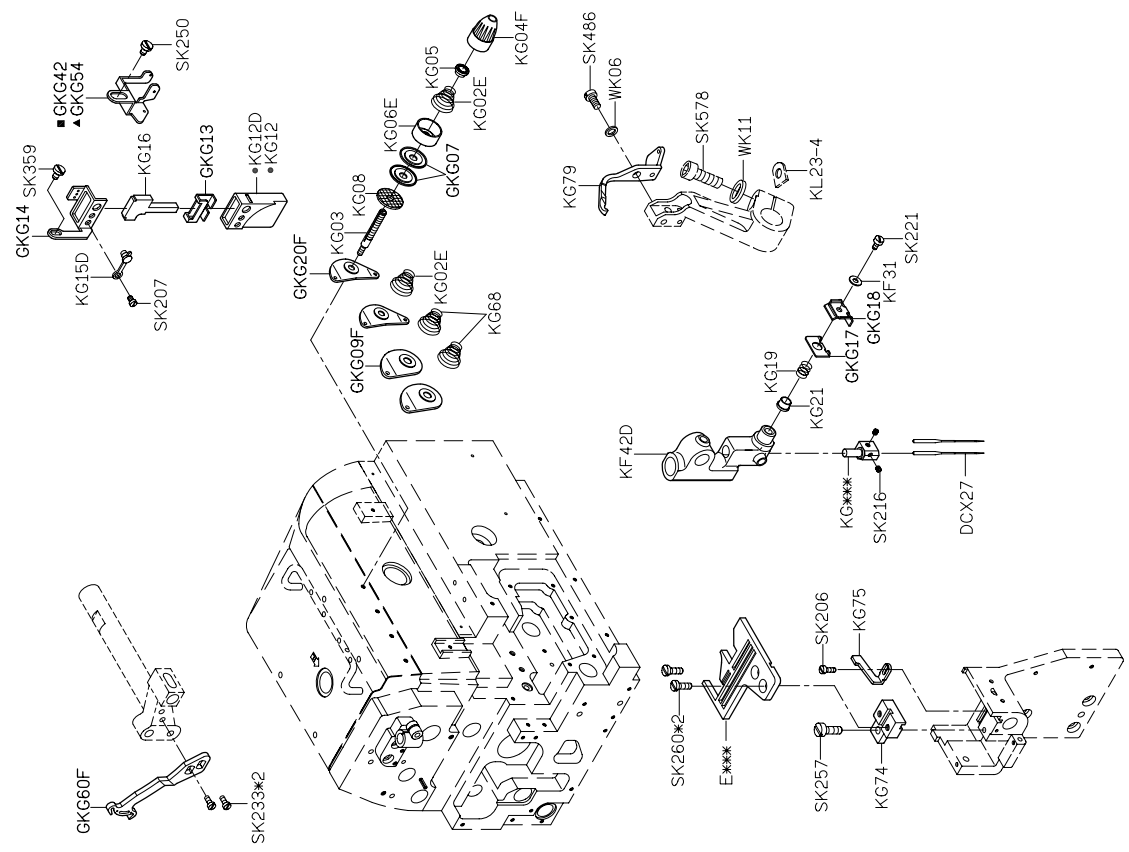

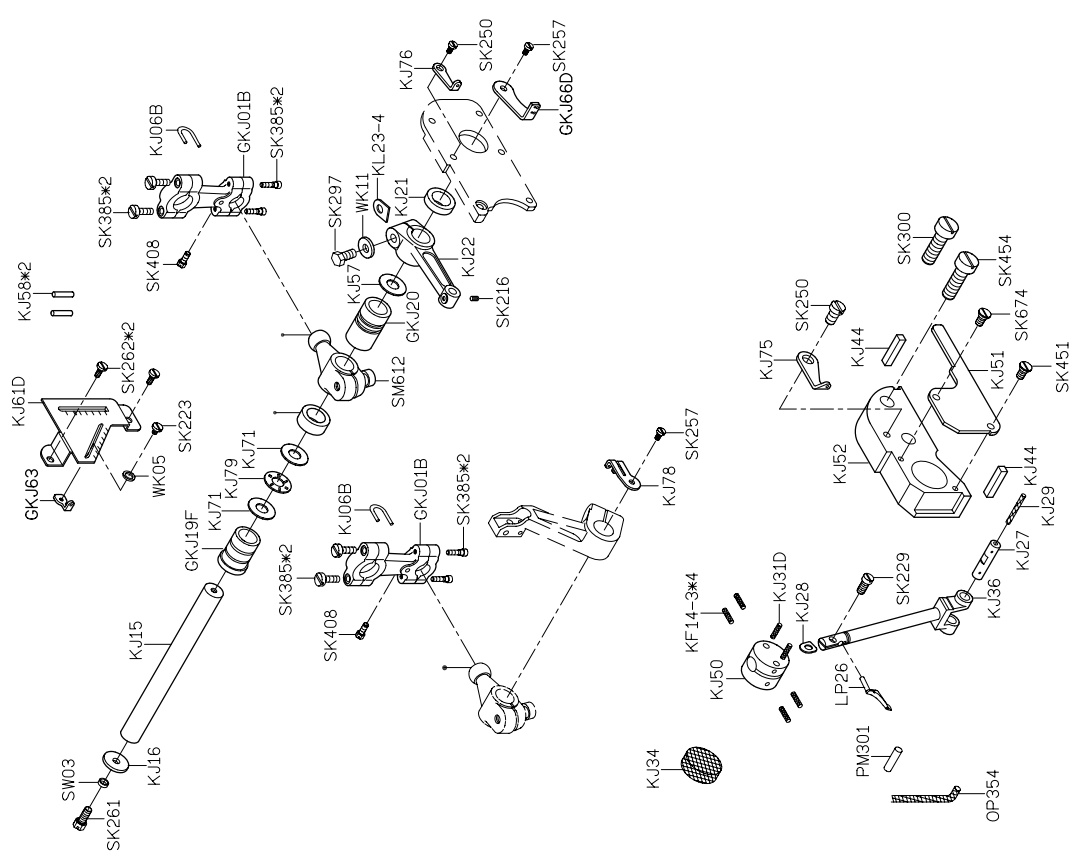
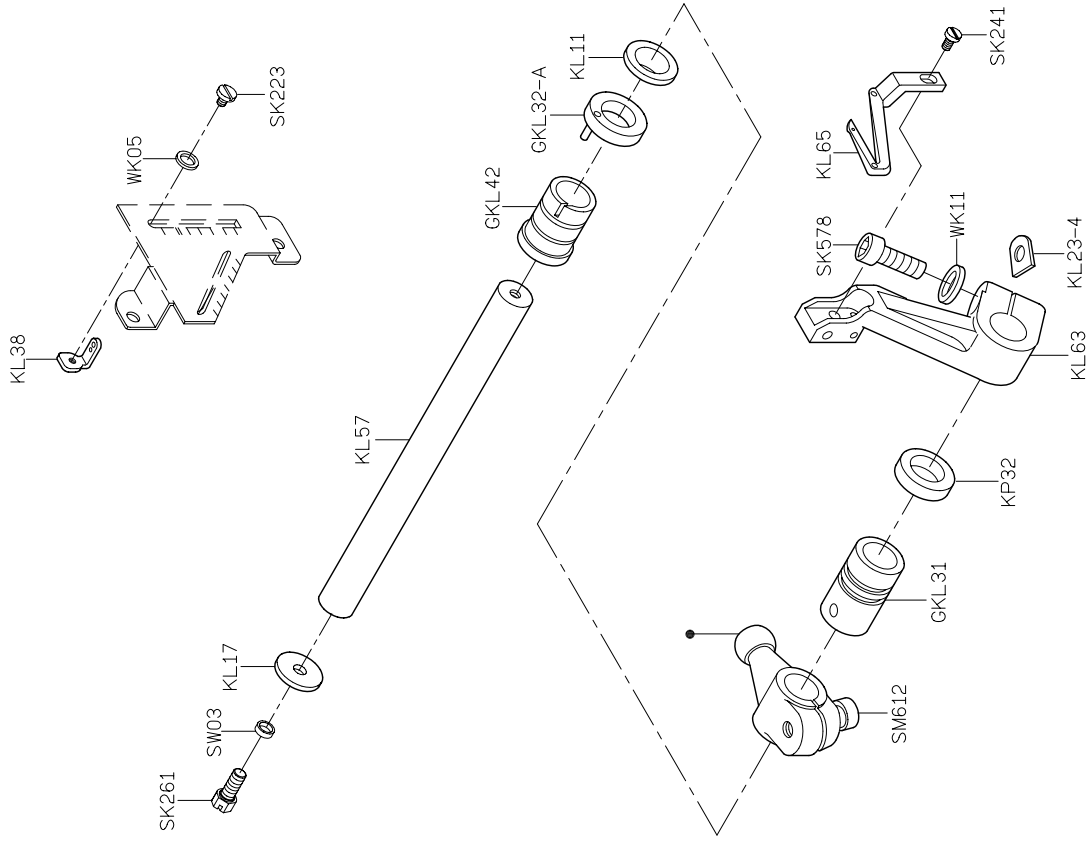

PARTS LIST FOR KL GROUP

PARTS LIST FOR KJ GROUP

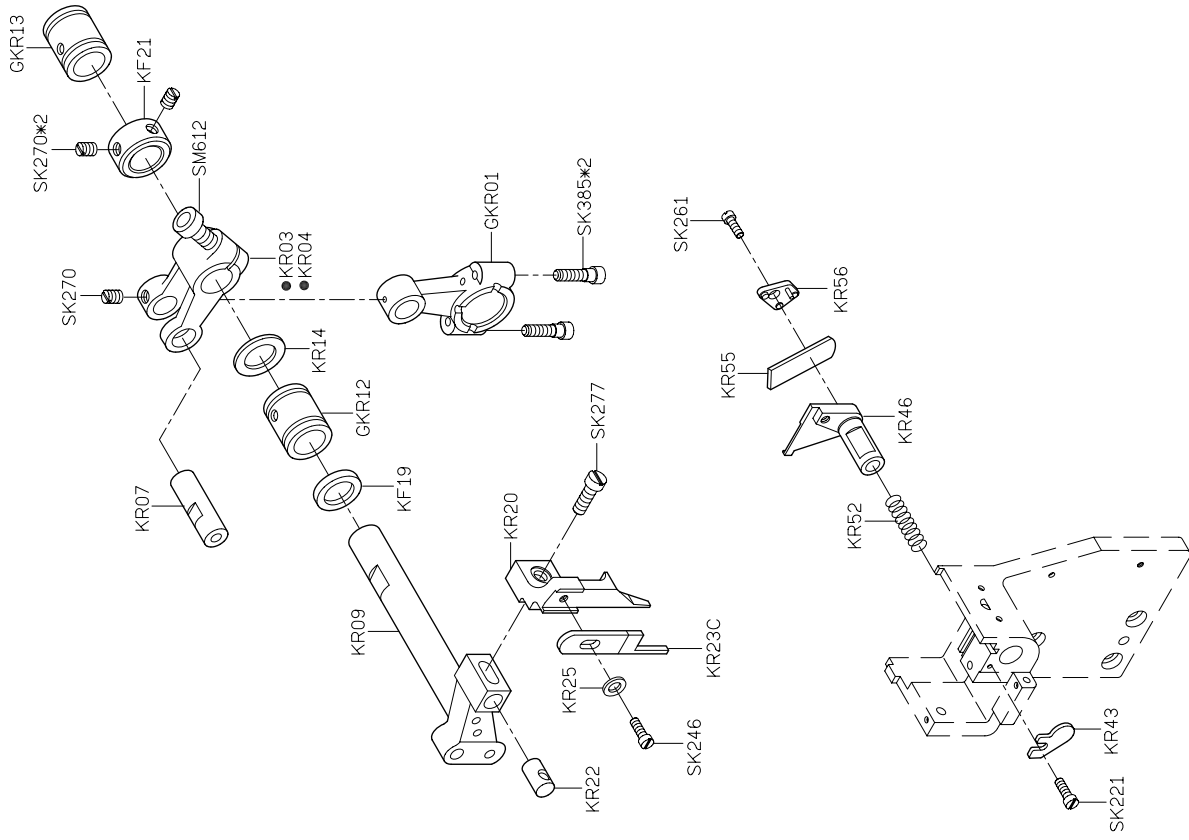

PARTS LIST FOR KR GROUP

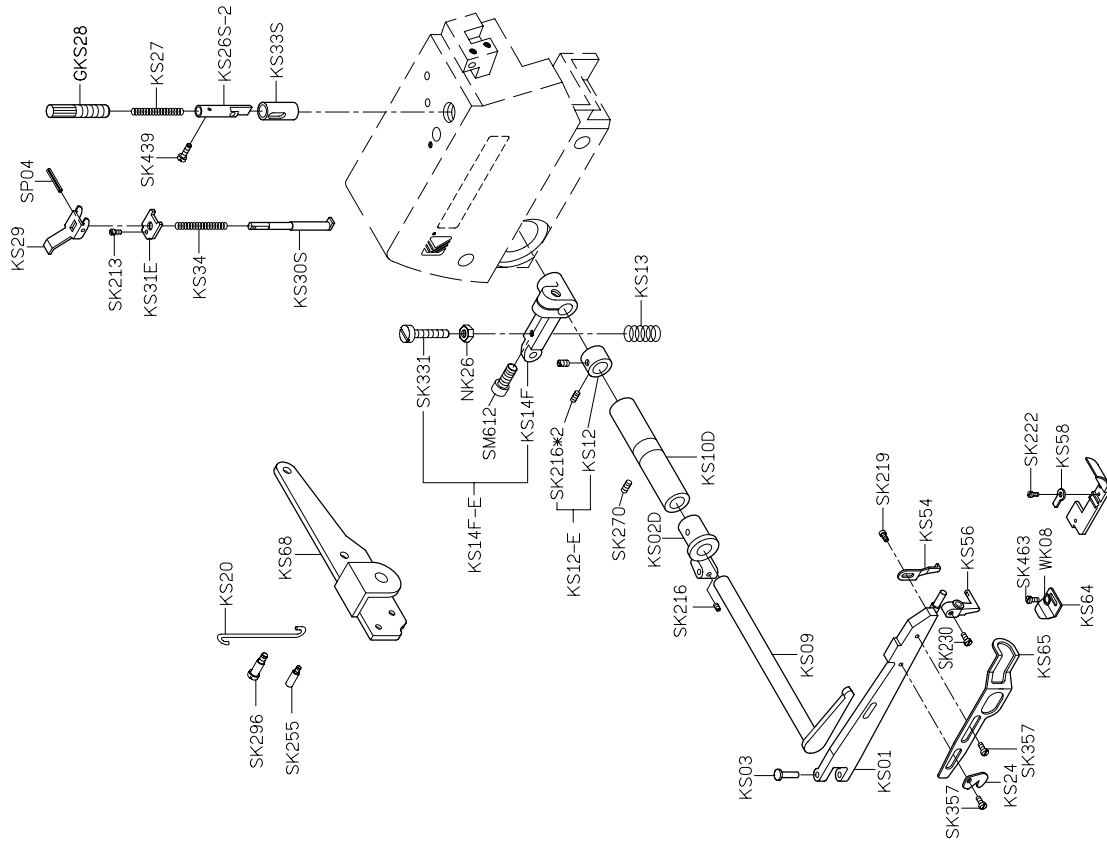

PARTS LIST FOR KS GROUP

PARTS LIST FOR KT GROUP

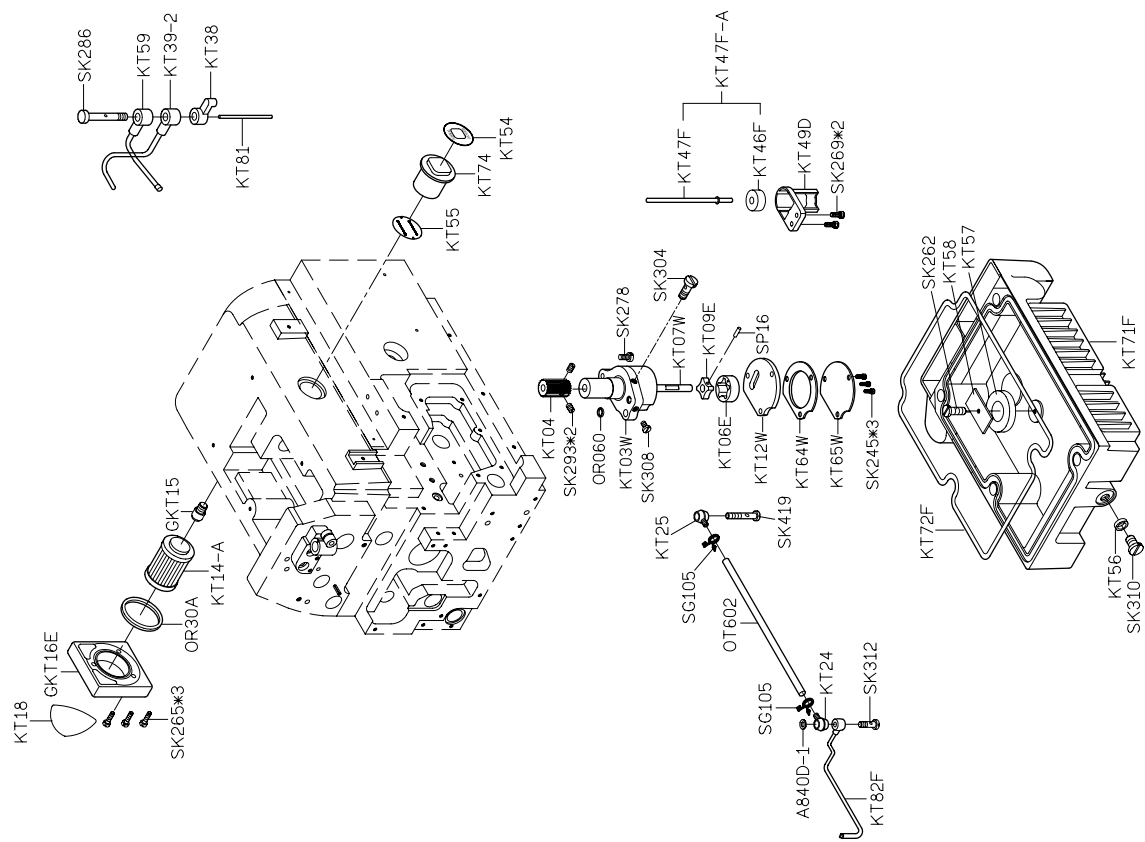



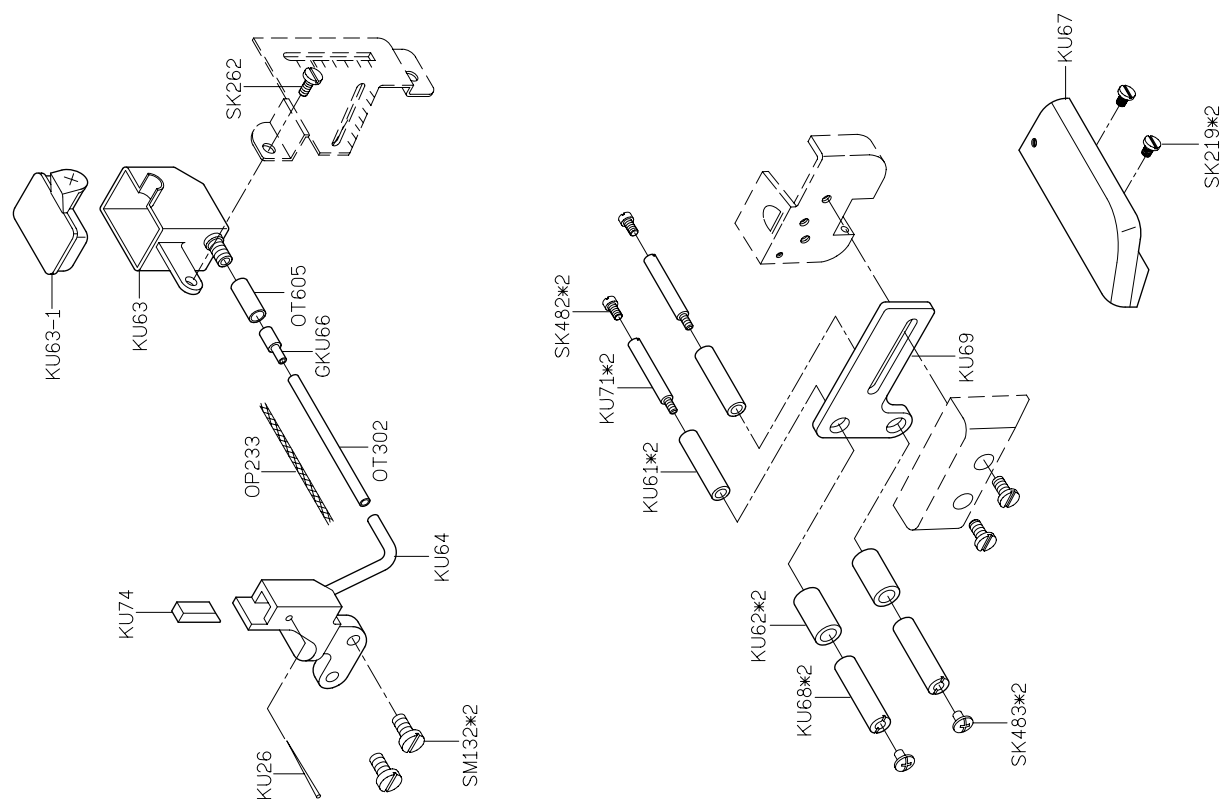



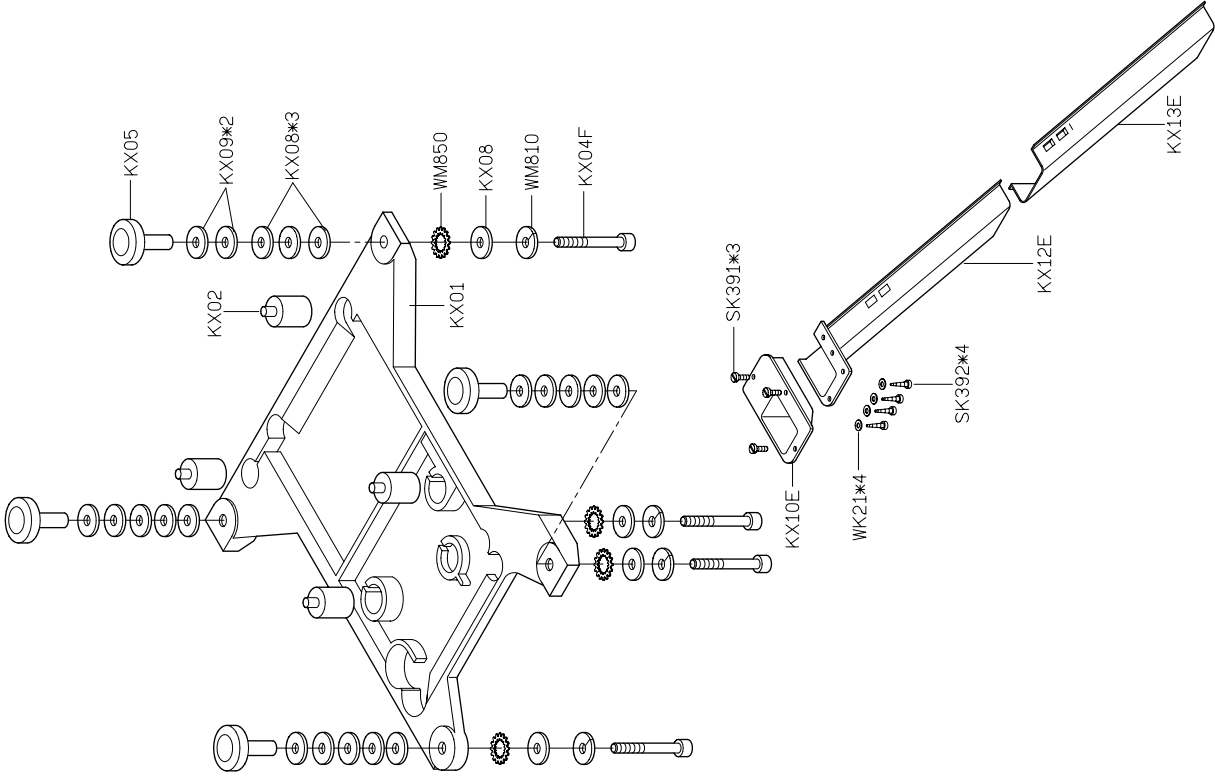



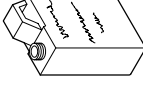
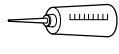









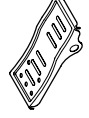

PARTS LIST FOR KU GROUP



PARTS LIST FOR KX GROUP

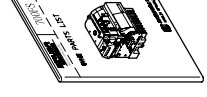
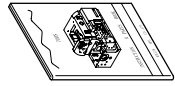

PARTS LIST FOR KY GROUP

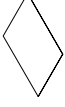
GKY01-1 防塵罩 	KY02-A 油罐 	KY03 油壺 	KY04S 漏斗 	KY05 油壺 
KY07 開口板手 	KY08 開口板手 	KY09 開口板手 	KY10 六角板手 	KY11 六角板手 
KY12 六角板手 	KY14 內六角螺絲起子 	KY16 一字起子 	KY17 一字起子 	KY18 鑷子 
GKY20D 腳踏板 	KY21-A/MY21 鉤子/鍊條 	GKY26F 工具袋 	KR55 下刀片 	KT14-A 濾油器 
MY11 六角板手 	KZ03 乾燥劑 	針*4 	KZ08FS 零件圖 	KZ13 使用說明書 
SK216 螺絲 	KY30 針板紙 			

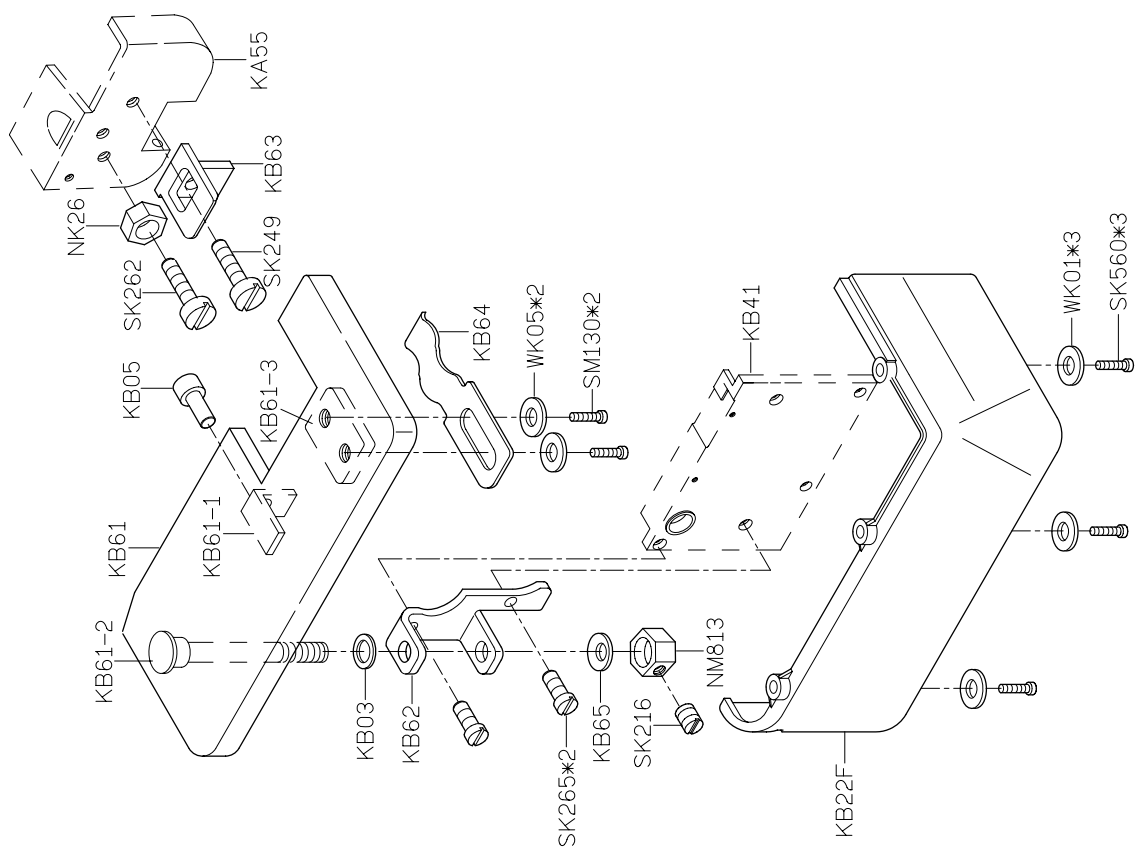
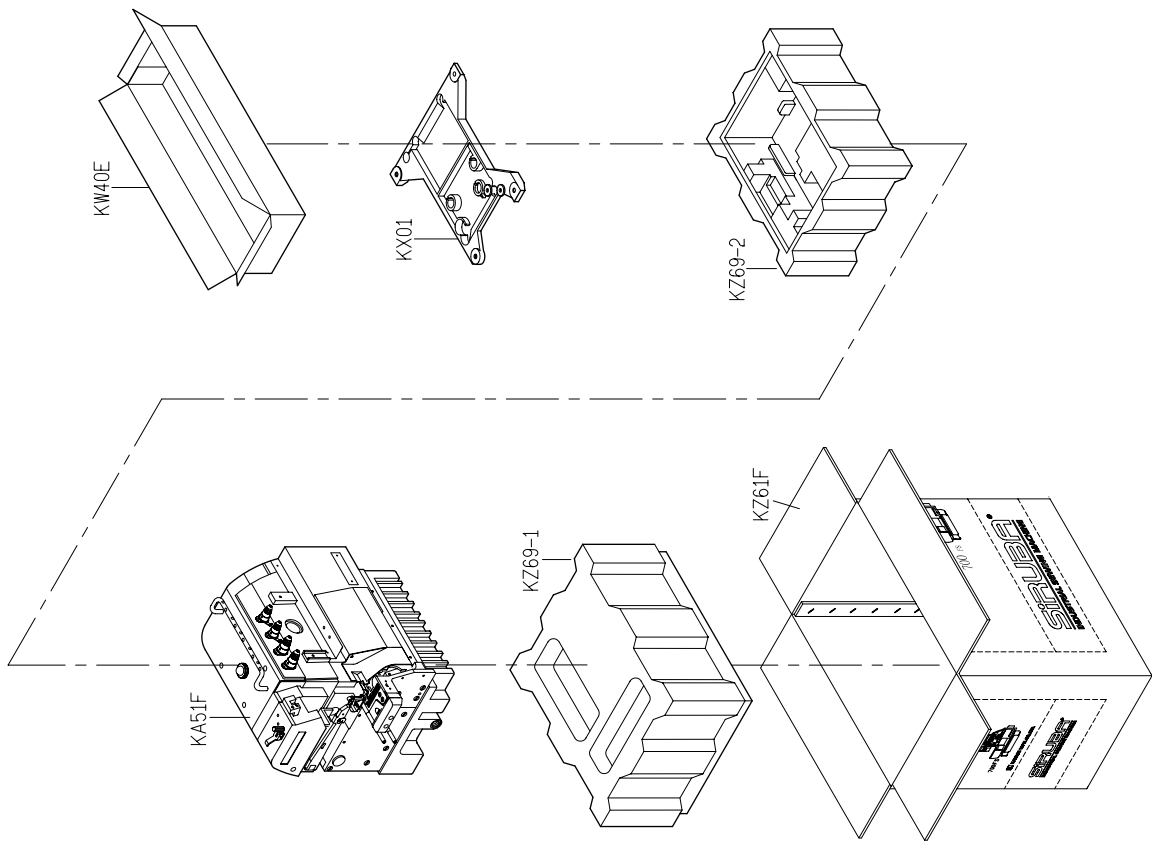

PARTS LIST FOR KZ GROUP

PARTS LIST FOR Cloth Plate GROUP

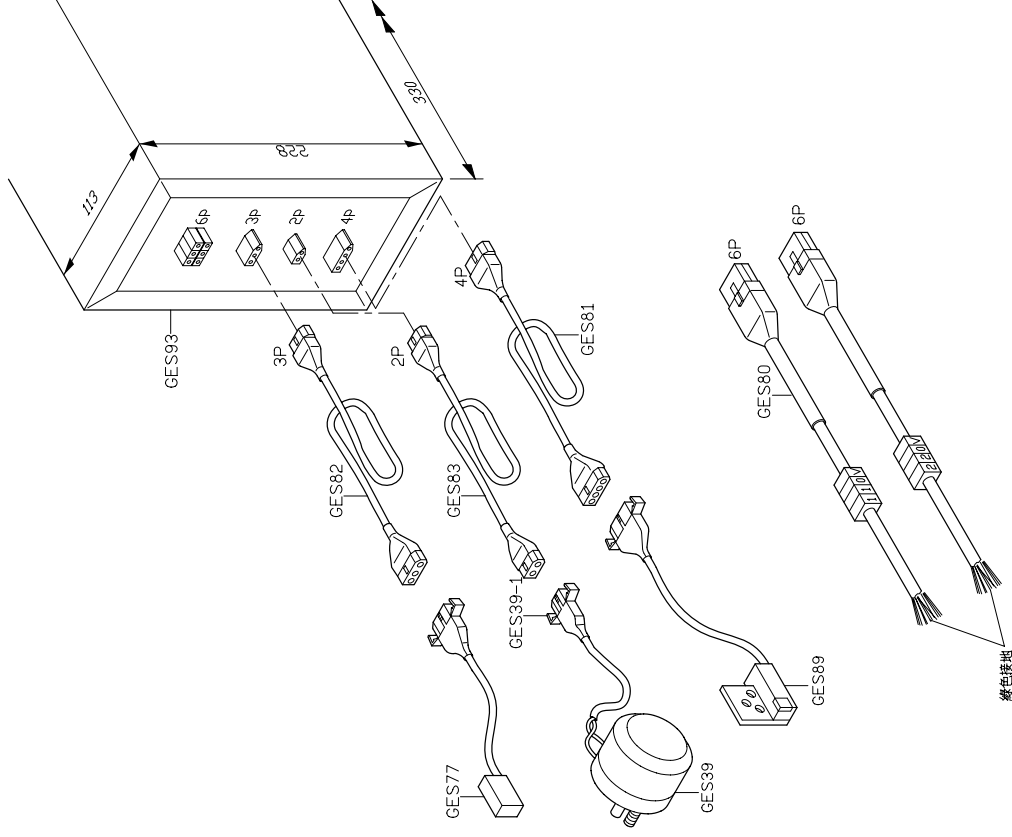
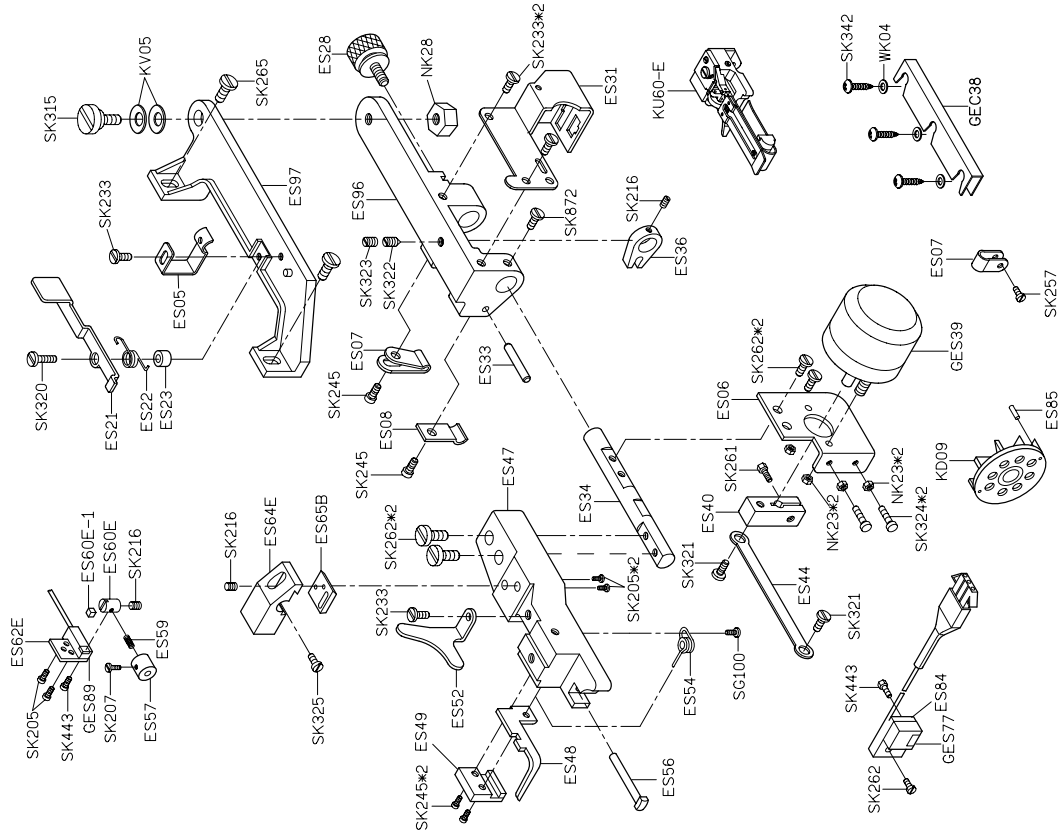

※ 內銷附上110V及220V各一條
外銷已指定地區則附上一條110V或220V



700FS

高林股份有限公司 KAULIN MFG. CO., LTD.