

SIRUBA®

銀爺牌工業用縫紉機

INDUSTRIAL SEWING MACHINE

L818F-NF

零件圖 PARTS LIST



CE



高林股份有限公司
KAULIN MFG. CO., LTD.







								
MODEL	SUB-CLASS	NEEDLE PLATE	FEED DOG	PRESSER FOOT	HOOK ASM	BOBBIN CASE ASM	BOBBIN	NEEDLE
機型	規格	針板	送具	押具	梭頭	梭殼	梭子	針號
L818F-NM1	薄至中厚布料	E706	D704	P708	G123	G201	G301	DB*1#14
L818F-NH1	中厚至厚布料	E707	D714	P714	G124	G201	G301	DB*1#22



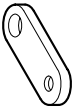

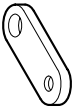
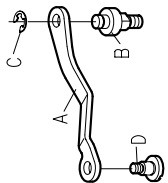
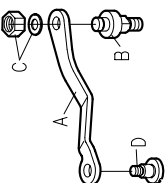
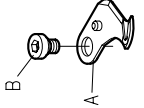
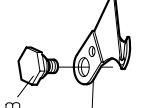

別件對照表 MODEL COMPARE LIST

MODEL 機 型	SUB-CLASS 規 格	SPRING 控線彈簧	SPRING 控線彈簧	SPRING 挑線彈簧	THREAD GUIDE 擋環片	SPRING 壓簧	THREAD GUIDE 導線杆	EJECTOR PIN 頂出銷	ADJUSTING KNOB 調整旋鈕	REGULATOR 調整銷
L818F /NM1	薄布料 ~ 中厚料	LA31	LA22	LA27	A LA17	LB204	LN72	LB12	LC23G	LH11
					B SK613					
L818F /NH1	中厚料 ~ 厚布料	LA131	LA122	LA27	A LA150	LB04	LN72	LB12	LC623G	LH11
					B SK689					

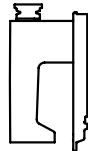
MODEL 機 型	SUB-CLASS 規 格	CONNECTING ROD SENT	FIXED PIN	HOOK FIXER	THRAD TAKE UP LEVER	CRANK SHAFT	THREAD GUIDE	NEEDLE BAR	SPRING	ECCENTRIC
L818F /NM1	薄布料 ~ 中厚料	LN35D	LC13	LE14	LG13	LG15	LG109	LN37	LN31	LN38
L818F /NH1	中厚料 ~ 厚布料	LN68	LC613	LE614	LG13	LG15	LG109	LN62	LN31	LN63

別件對照表 MODEL COMPARE LIST

										
MODEL	SUB-CLASS	SOLENOID BRACKET	PRESSER PLATE	FIXED PLATE	CONNECTING ROD	CONNECTING ROD	MOVABLE KNIFE	MOVABLE KNIFE	MOVABLE KNIFE	MOVABLE KNIFE
機 型	規 格	電磁閥座	押板	固定片	連桿	連桿	活動刀	活動刀	活動刀	活動刀
L818F /NM1	薄布料 ~ 中厚料	LU26	LU04	LU28	A LU15 B SK662 C EM050 D SK664	—	A LU02 B SK660	—	—	—
L818F /NH1	中厚料 ~ 厚布料	LU626	LU604	LU628	A LU615 B SK677 C NK26/WM402 D SK682	—	—	—	A LU602 B SK683	—

 MODEL 機 型	 SUB-CLASS 規 格	 MOVABLE KNIFE CONNECTING ROD 活動刀連桿	 MOVABLE KNIFE CONNECTING ROD 活動刀連桿	 PRESSER PLATE 刀座	 MOVABLE KNIFE 轉子連桿	 TRIMMER SOLENOID 切線電磁閥
L818F /NM1	薄布料 ~ 中厚料	LU01	—	LU03	LU18	LU25
L818F /NH1	中厚料 ~ 厚布料	—	LU601	LU603	LU618	LU625

別件對照表 MODEL COMPARE LIST

H1

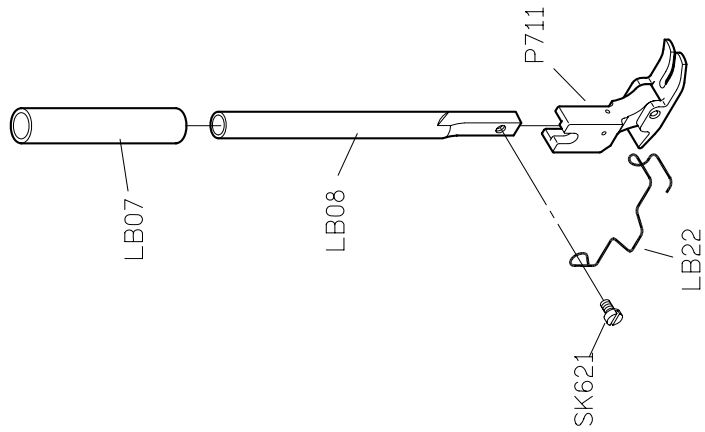

H1R

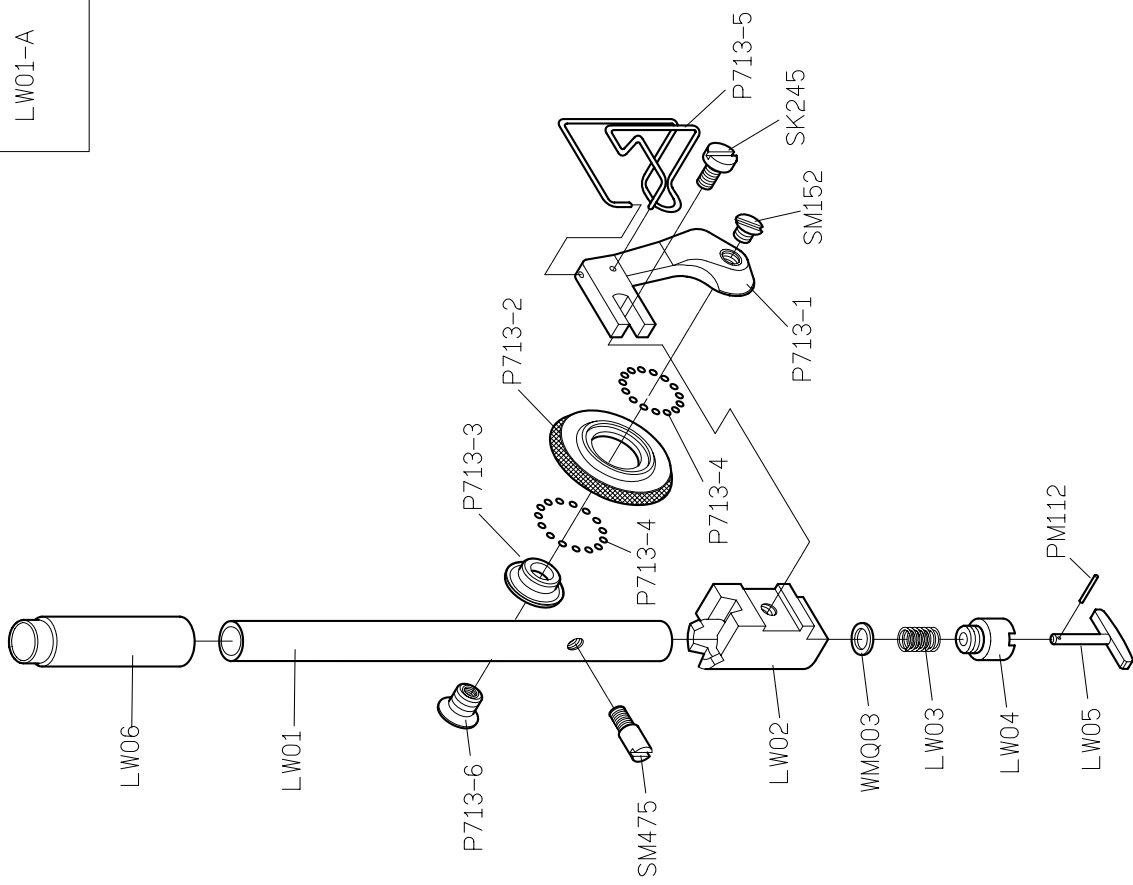

LW01-A

PARTS LIST FOR LC GROUP

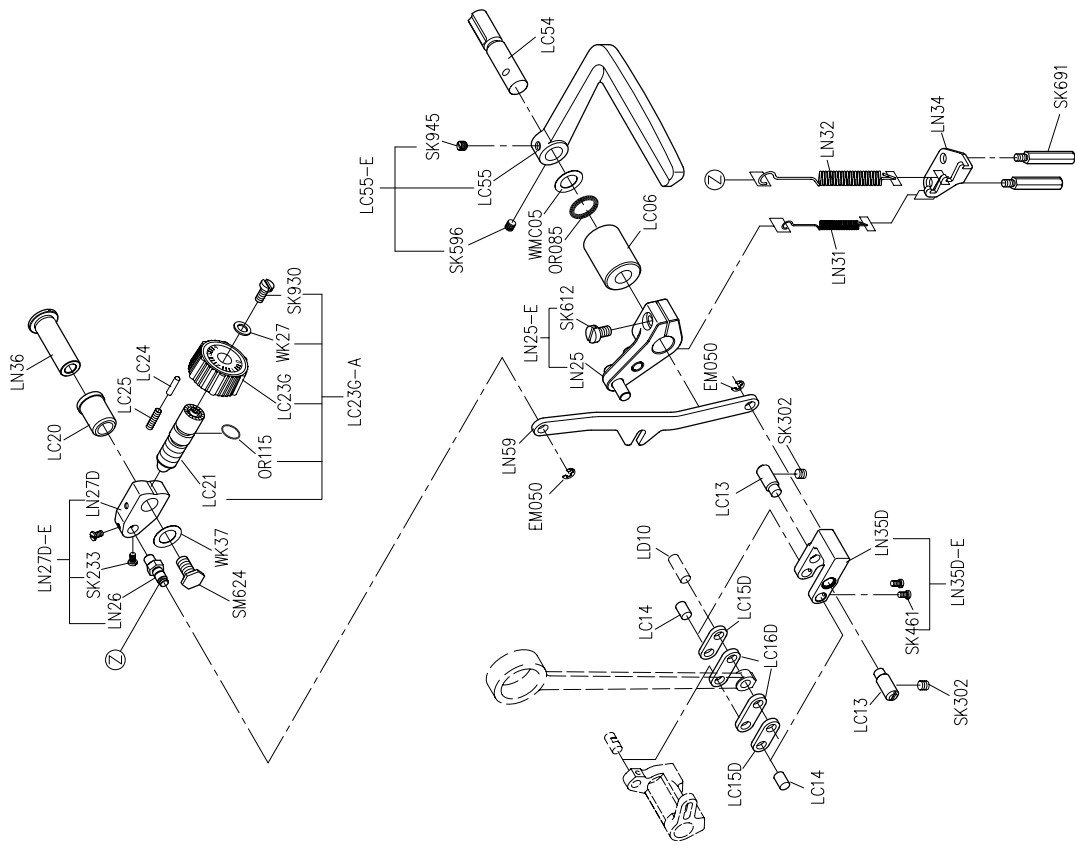

PARTS LIST FOR LD GROUP

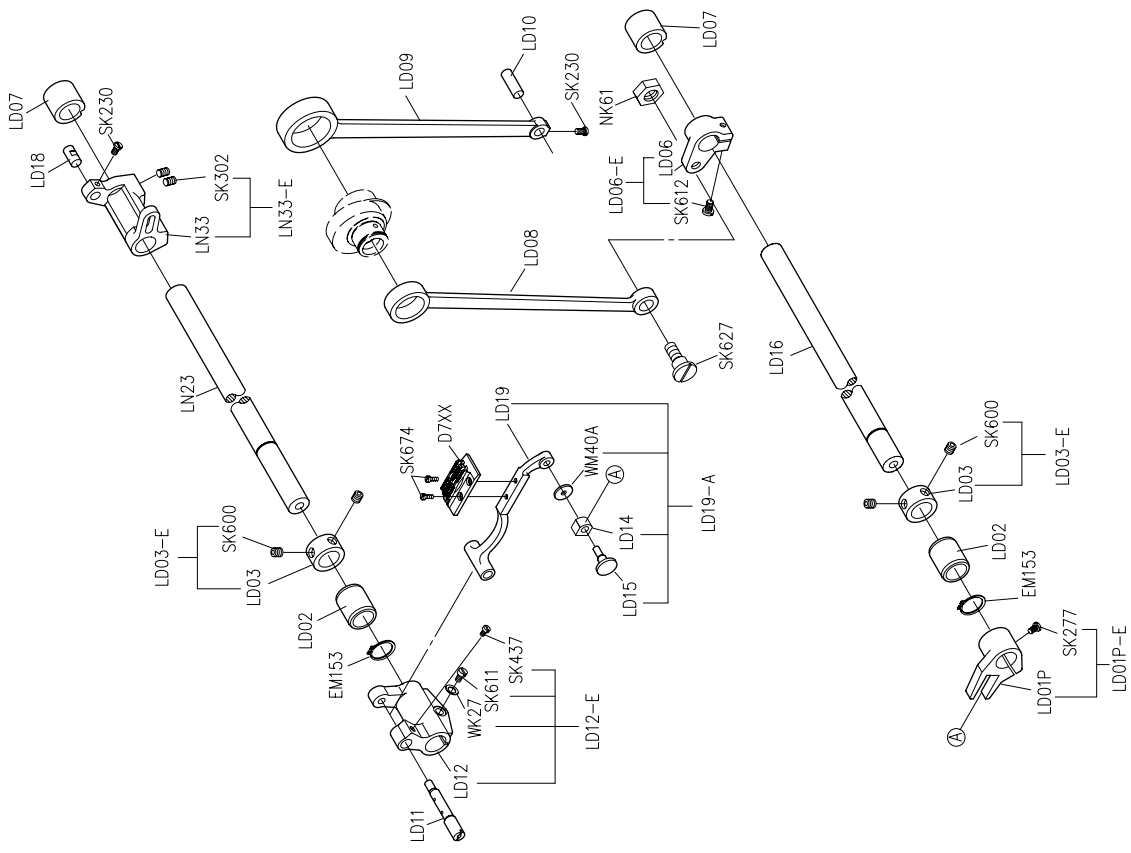

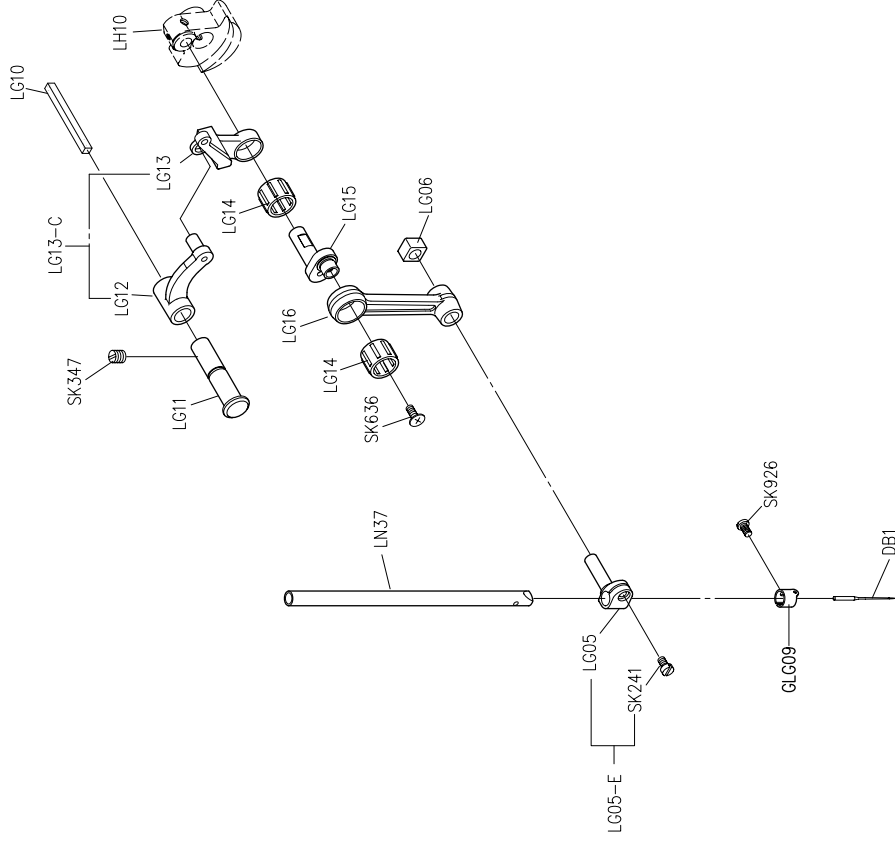
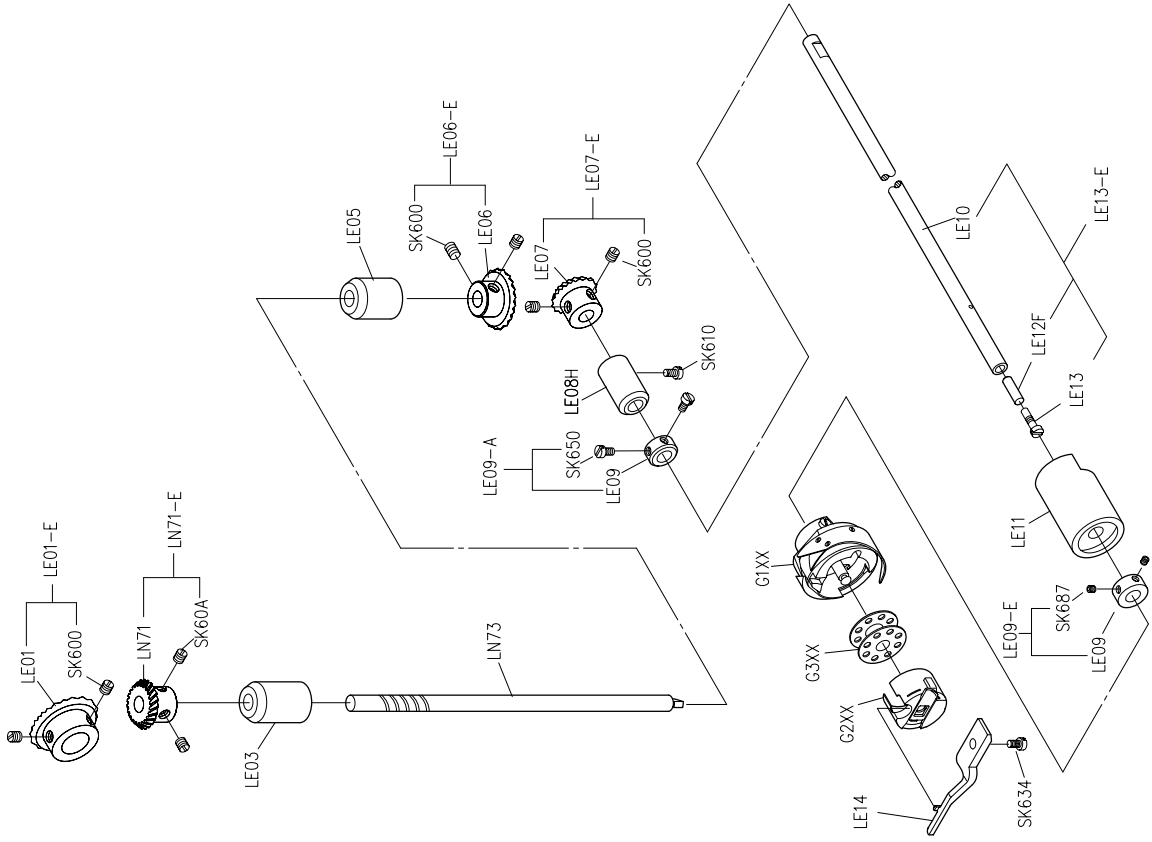

PARTS LIST FOR LE GROUP

PARTS LIST FOR LG GROUP

PARTS LIST FOR LH GROUP

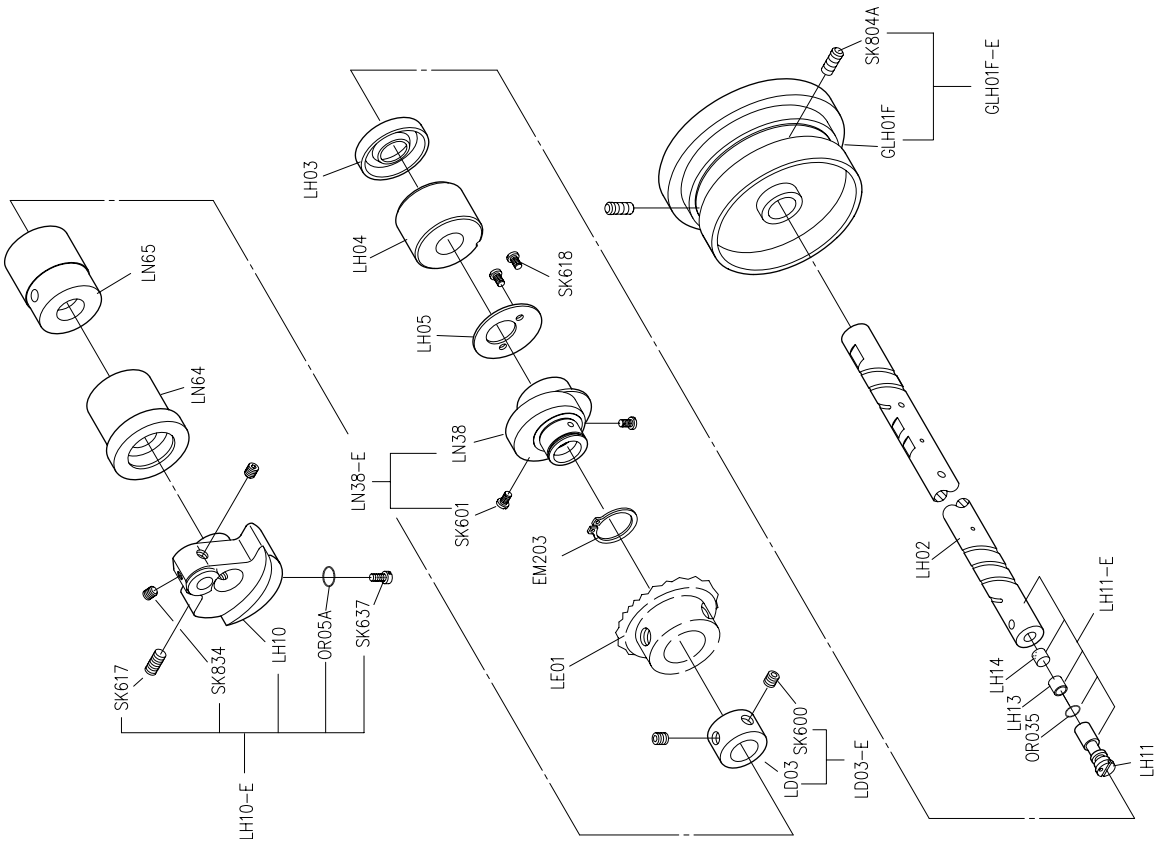

PARTS LIST FOR LL GROUP

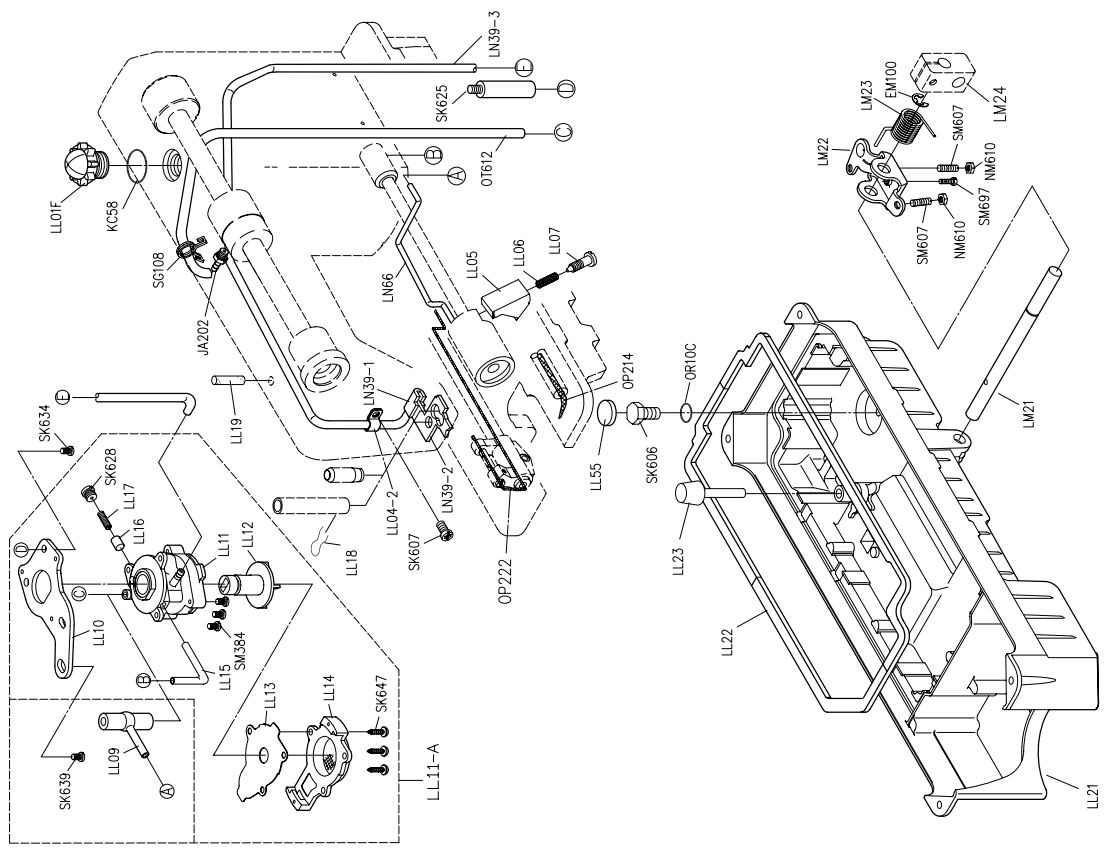

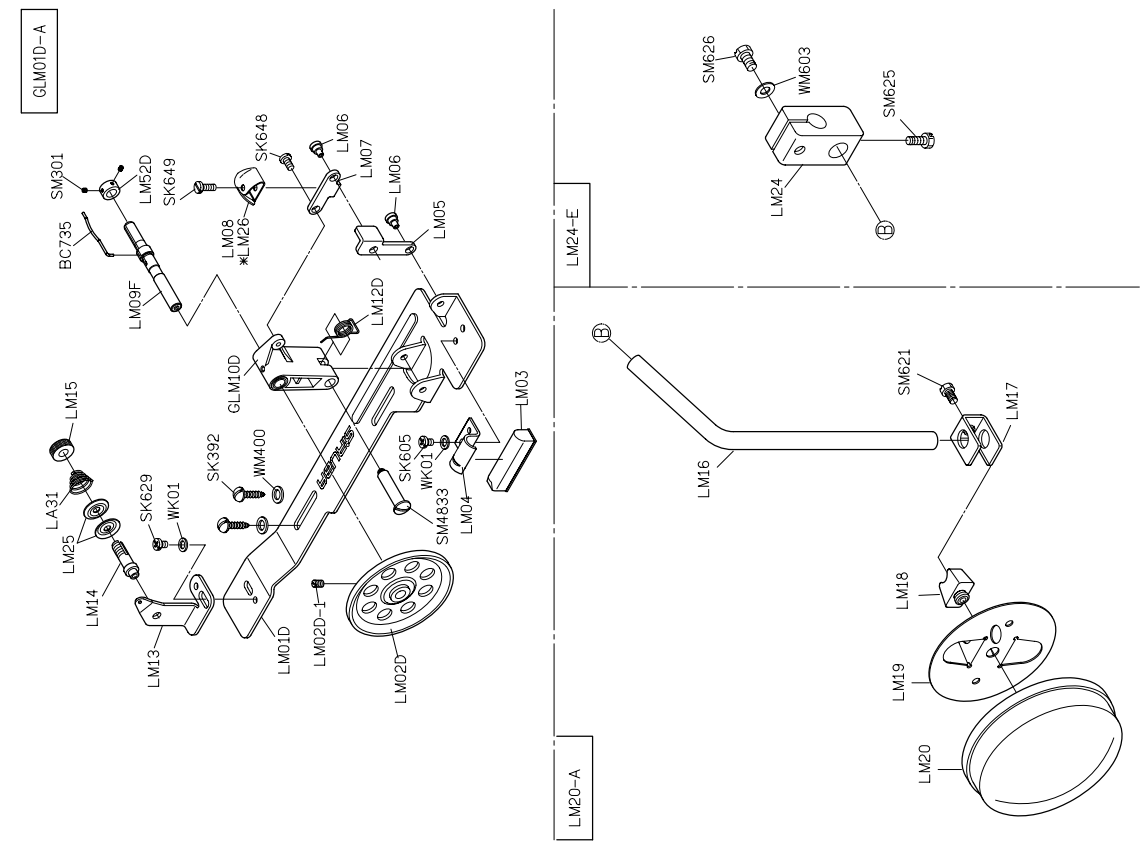



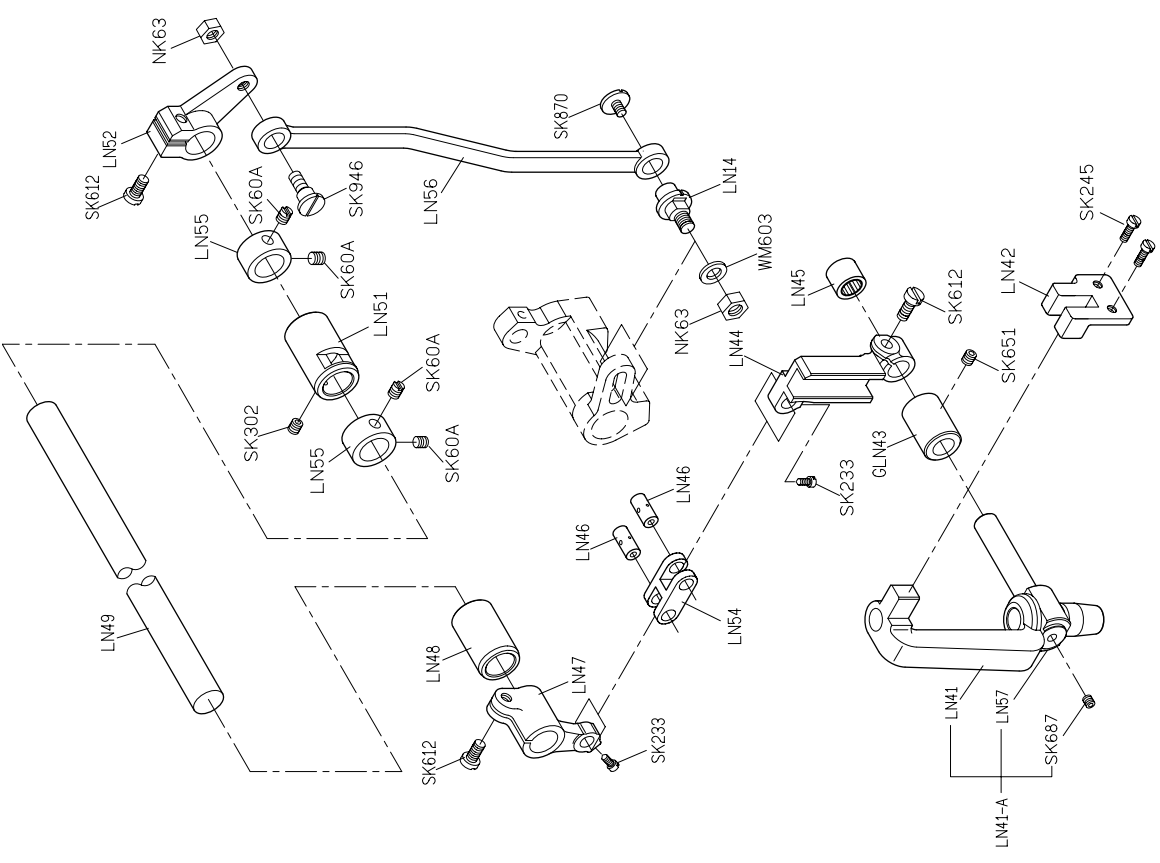





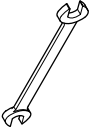

PARTS LIST FOR LM GROUP

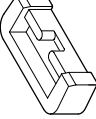
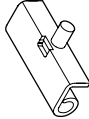

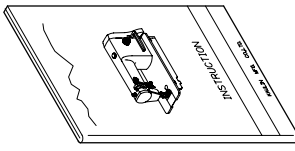
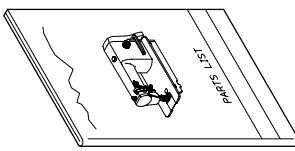
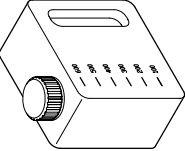
PARTS LIST FOR LN GROUP

PARTS LIST FOR LY GROUP

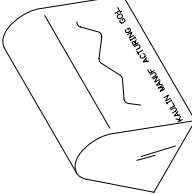
PARTS LIST FOR LZ GROUP

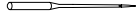
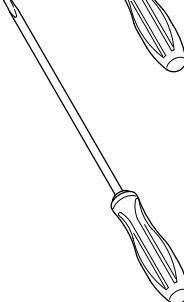
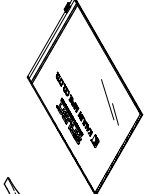
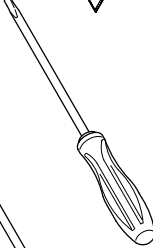
L Y01					
L Y02					
Y M04*2					
L Y05*2					
Y M102*2					
L Y30					
L Y32					
L Y21-A		Y M103*2			
G3XX*2		L Y20*8			
GMY01		KZ03*1			
MY11					
MY13					
KY16		GKY26F			
KY17					

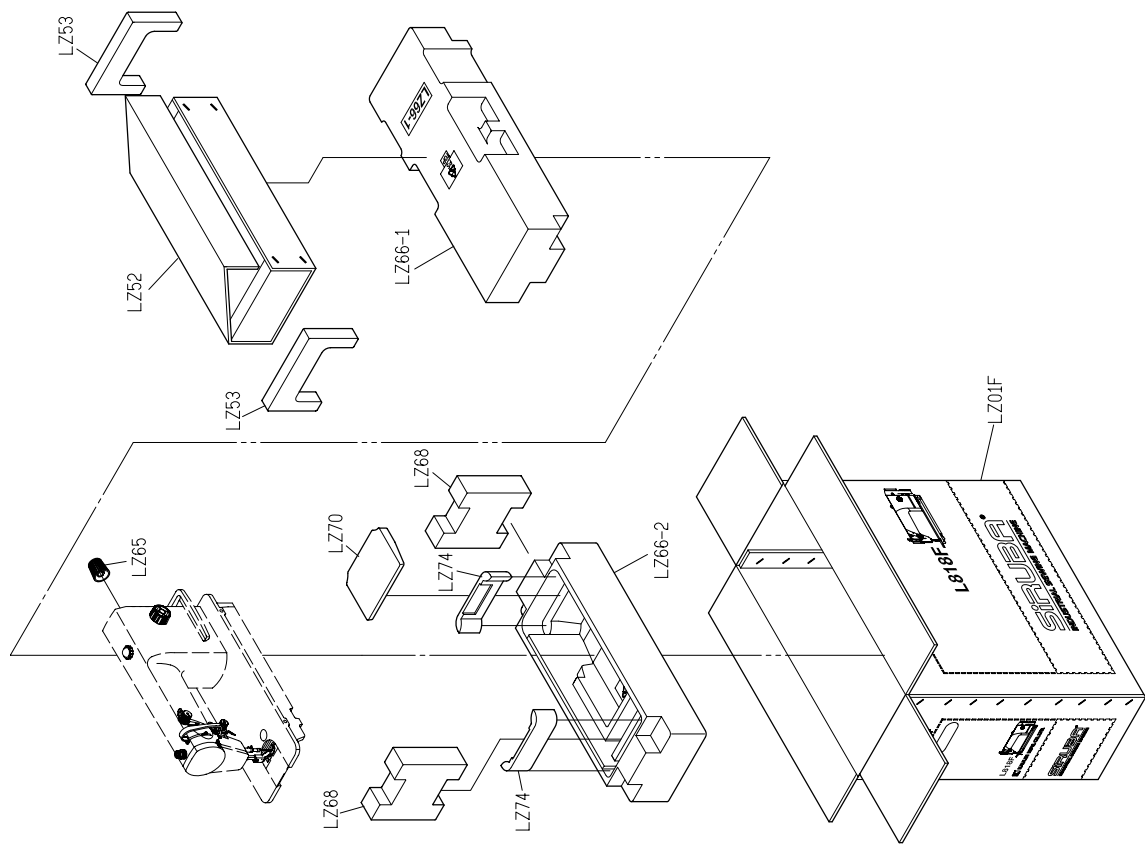

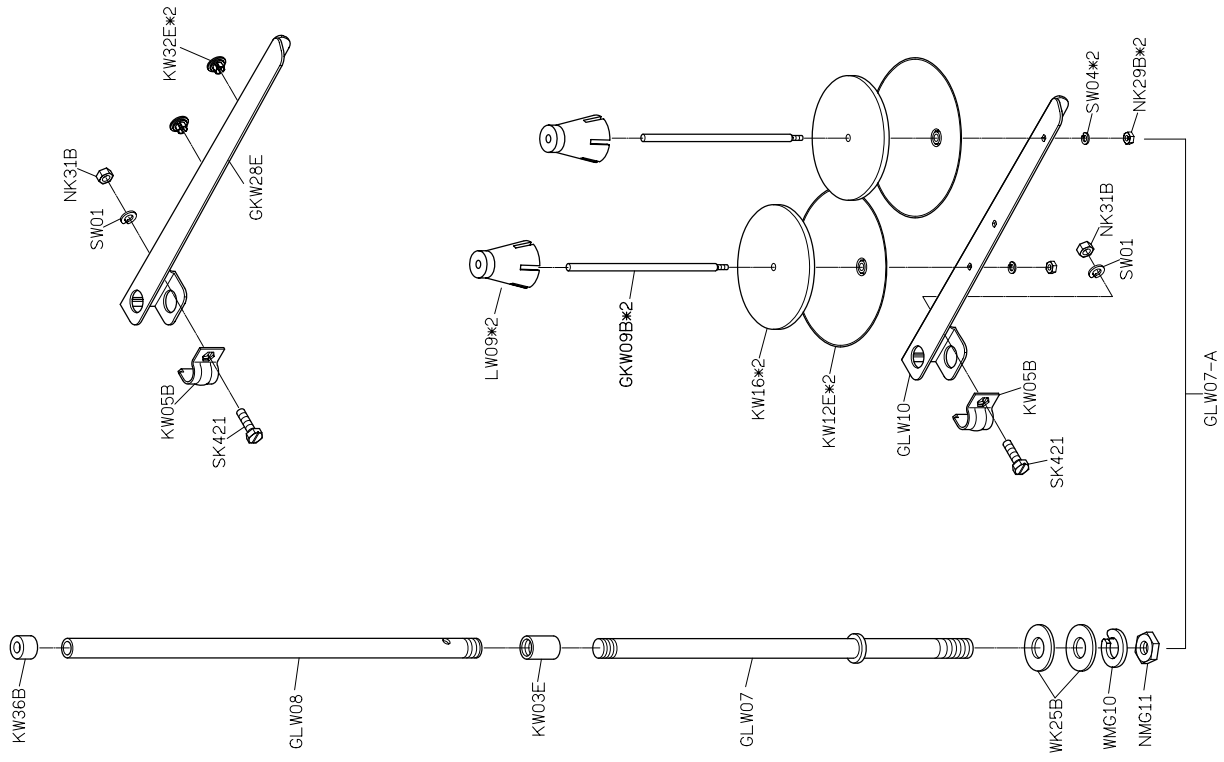

PARTS LIST FOR THREAD STAND GROUP



L818F-NF

高林股份有限公司 KAULIN MFG. CO., LTD.